

LOW POWER AND LOW OFFSET VOLTAGE SUPER SMALL-SIZED SINGLE C-MOS COMPALATOR

■GENERAL DESCRIPTION

The **NJU7118** is a super small-sized package single C-MOS comparators with open drain output.

The operating voltage is from 1V to 5.5V, and the interface can be connected with most of TTL and C-MOS type standard logic ICs.

Furthermore, The input offset voltage is lower than 4mV and the package is super small-sized SC88A, therefore they can be suitable for battery use items and other portable items.

■PACKAGE INFORMATION



NJU7118F2

■FEATURES

- Single Low Power Supply
- Low Offset Voltage
- Low Operating Current
- Open Drain Output
- Package Outline
- C-MOS Technology

$V_{DD}=1.0\sim 5.5V$

$V_{IO}=4mV$ max

$I_{DD}=10\mu A$ typ

SC88A

■PIN CONFIGURATION

(Top View)

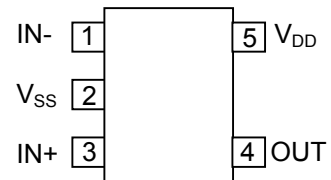

■EQUIVALENT CIRCUIT

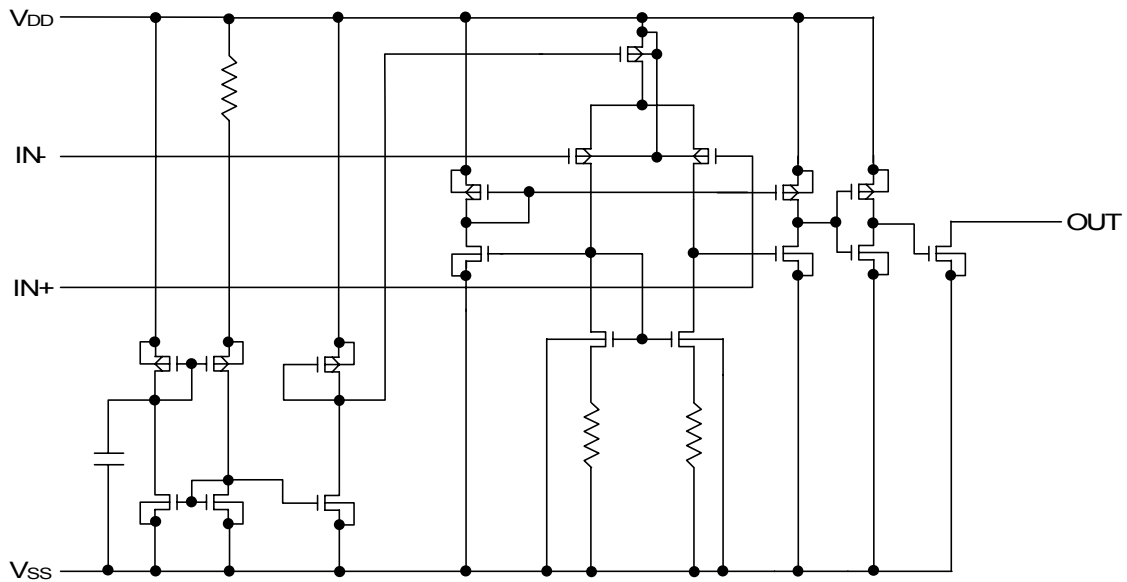

■ABSOLUTE MAXIMUM RATINGS

(Ta=25°C)

PARAMETER	SYMBOL	RATING	UNIT
Supply Voltage	V _{DD}	7.0	V
Differential Input Voltage	V _{ID}	±7.0 (Note1)	V
Common Mode Input Voltage	V _{IC}	-0.3~7.0	V
Power Dissipation	P _D	250 (Note2)	mW
Operating Temperature	Topr	-40~+85	°C
Storage Temperature	Tstg	-55~+125	°C

Note1) If the supply voltage (V_{DD}) is less than 7.0V, the input voltage must not over the V_{DD} level though 7.0V is limit specified.

Note2) The power dissipation is value mounted on a glass epoxy board (FR-4) in size of 50x50x1.6 millimeters square.

Note3) Decoupling capacitor should be connected between V_{DD} and V_{SS} due to the stabilized operation for the circuit.

■ELECTRICAL CHARACTERISTICS

 (V_{DD}=3.0V, R_L=∞, Ta=25°C)

PARAMETER	SYMBOL	CONDITIONS	MIN	TYP	MAX	UNIT
Operating Voltage	V _{DD}		1.0	-	5.5	V
Input Offset Voltage	V _{IO}	V _{IN} =V _{DD} /2	-	-	4	mV
Input Offset Current	I _{IO}		-	1	-	pA
Input Bias Current	I _{IB}		-	1	-	pA
Input Common Mode Voltage Range	V _{ICM}		0~2.5	-	-	V
Low Level Output Voltage	V _{OL}	I _{OL} =+5mA	-	-	0.3	V
Operating Current	I _{DD}		-	10	20	uA

 (V_{DD}=3.0V, f=10kHz, C_L=15pF, Ta=25°C)

PARAMETER	SYMBOL	CONDITIONS	MIN	TYP	MAX	UNIT
Propagation Delay Low to High	t _{PLH}	Over Drive=100mV	-	540	-	ns
Propagation Delay High to Low	t _{PHL}	Over Drive=100mV	-	190	-	ns
Output Signal Falling Time	t _{THL}	Over Drive=100mV	-	4	-	ns

■SWITCHING CHARACTERISTICS MEASUREMENT CIRCUIT

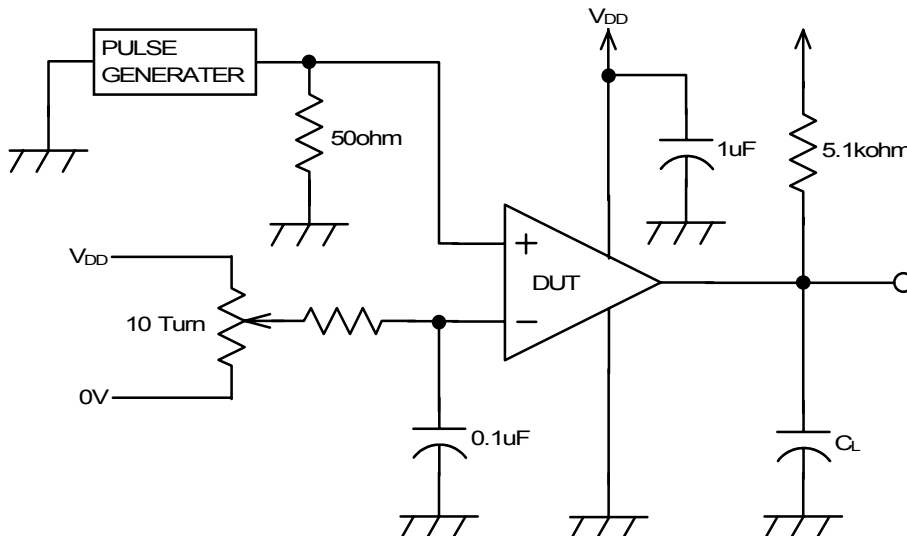

■TYPICAL CHARACTERISTICS

Output Voltage vs. Output Current (Sink)

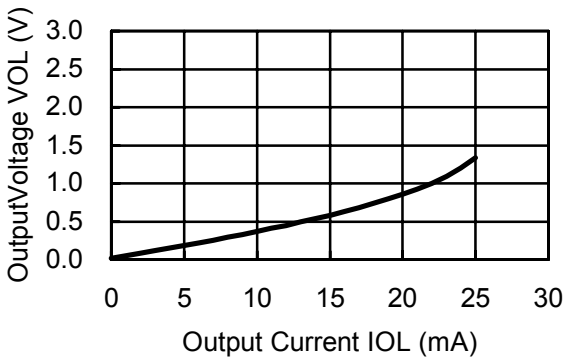

[CAUTION]
 The specifications on this data book are only given for information, without any guarantee as regards either mistakes or omissions. The application circuits in this data book are described only to show representative usages of the product and not intended for the guarantee or permission of any right including the industrial rights.